

# BEFD15-L810DS-P 4x6

--	--

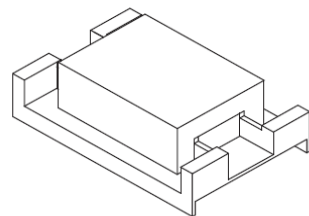

C-068 (C-077.001L)

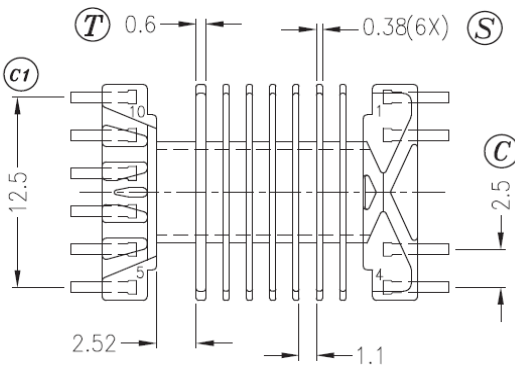
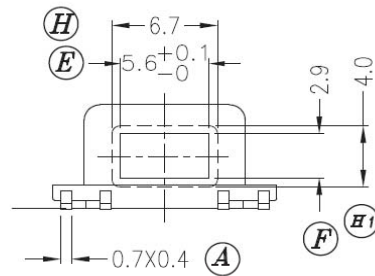
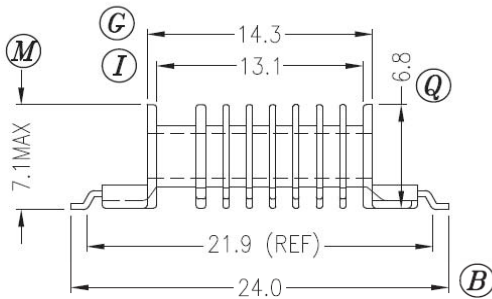
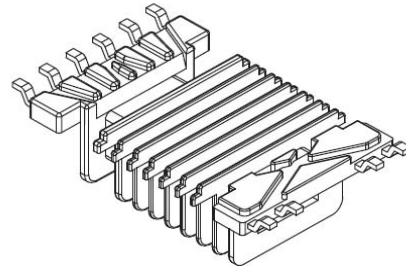
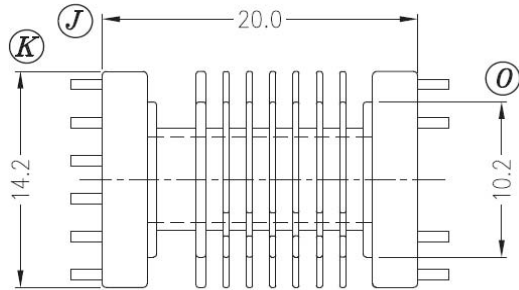
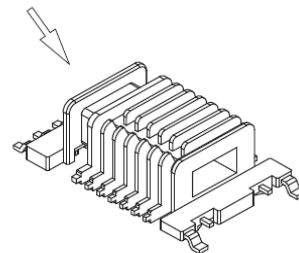

Dimensions in mm

Country of Origin: China	RoHS Certified: YES	Molder UL File Number: E163831
Bobbin Material: Sumitomo E4008 (k) (LCP)	Drawing Number: BEFD15-L810DS-P 4x6	
UL File: E54705	UL Rec: 94-V0	S-1507
Pin Material: Phosper Bronze (DS)		Pin Tension: 2.0Kgm min
Finish: Tin		Part Number: BEFD15-L810DS-P 4x6
<b>MH&amp;W International Corp</b> Phone 201-891-8800 Email: sales@mhw-intl.com		