

- In accordance with IEC 61860
- For compact transformers
- Without center hole
- RM cores are supplied in sets

Magnetic characteristics (per set)

$$\Sigma l/A = 0,44 \text{ mm}^{-1}$$

$$l_e = 28,7 \text{ mm}$$

$$A_e = 64,9 \text{ mm}^2$$

$$A_{\min} = 55,4 \text{ mm}^2$$

$$V_e = 1860 \text{ mm}^3$$

Approx. weight 9,2 g/set

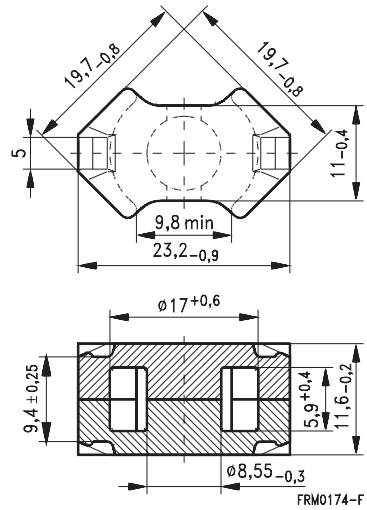
Ungapped

Material	A_L value nH	μ_e	$A_{L1\min}$ nH	P_V W/set	Ordering code
N49	2900 + 30/- 20 %	1020	2000	< 0,33 (50 mT, 500 kHz, 100 °C)	B65811-P-R49
N92 ¹⁾	3100 + 30/- 20 %	1100	2550	< 1,10 (200 mT, 100 kHz, 100 °C)	B65811-P-R92
N87	4100 + 30/- 20 %	1440	2550	< 0,92 (200 mT, 100 kHz, 100 °C)	B65811-P-R87

1) Preliminary data

Coil former

Material: GFR polyterephthalate (UL 94 V-0, insulation class to IEC 60085:
H \triangleq max. operating temperature 155 °C), color code black

Solderability: to IEC 60068-2-20, test Ta, method 1 (aging 3): 235 °C, 2 s

Resistance to soldering heat: to IEC 60068-2-20, test Tb, method 1B: 350 °C, 3,5 s

Winding: see "Processing Notes", page 153

Squared pins

For matching clamp and insulating washers see page 234

Sections	A_N mm ²	l_N mm	A_R value $\mu\Omega$	Pins	Ordering code
1	14,3	42	101	10	B65812-P1010-D1

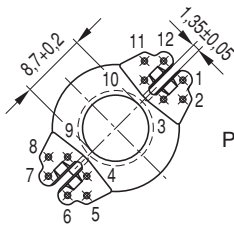

Pins 5 and 8 omitted

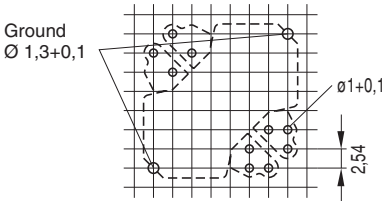
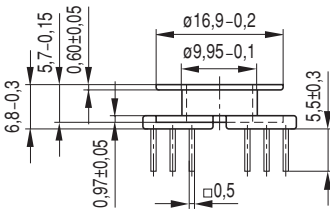

Hole arrangement
View in mounting direction

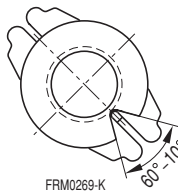

Clamp

- With ground terminal, made of stainless spring steel (tinned), 0,4 mm thick
- Solderability to IEC 60068-2-20, test Ta, method 1 (aging 3): 235 °C, 2 s
- Also available as strip clamp on reels

Insulating washer 1 between core and coil former

- For tolerance compensation and for insulation
- Made of polycarbonate (UL 94 V-0, insulation class to IEC 60085: E \triangleq 120 °C), 0,08 mm thick

Insulating washer 2 for double-clad PCBs

- Made of polycarbonate (UL 94 V-0, insulation class to IEC 60085: E \triangleq 120 °C), 0,3 mm thick

	Ordering code
Clamp (ordering code per piece, 2 are required)	B65812-P2203
Insulating washer 1 (reel packing, PU = 1 reel)	B65812-A5000
Insulating washer 2 (bulk)	B65812-C2005

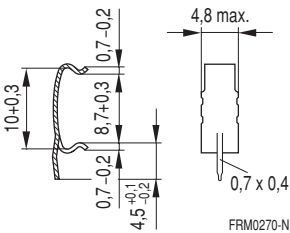
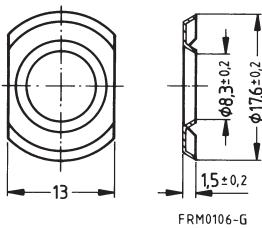
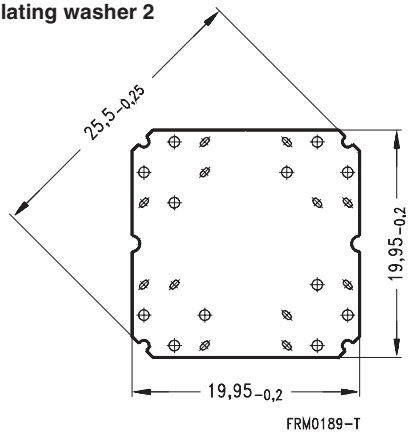
Clamp

Insulating washer 1

Insulating washer 2

Herausgegeben von EPCOS AG

Marketing Kommunikation, Postfach 80 17 09, 81617 München, DEUTSCHLAND

© EPCOS AG 2000. Alle Rechte vorbehalten. Vervielfältigung, Veröffentlichung, Verbreitung und Verwertung dieser Broschüre und ihres Inhalts ohne ausdrückliche Genehmigung der EPCOS AG nicht gestattet.

Mit den Angaben in dieser Broschüre werden die Bauelemente spezifiziert, keine Eigenschaften zugesichert. Bestellungen unterliegen den vom ZVEI empfohlenen Allgemeinen Lieferbedingungen für Erzeugnisse und Leistungen der Elektroindustrie, soweit nichts anderes vereinbart wird.

Diese Broschüre ersetzt die vorige Ausgabe.

Fragen über Technik, Preise und Liefermöglichkeiten richten Sie bitte an den Ihnen nächstgelegenen Vertrieb der EPCOS AG oder an unsere Vertriebsgesellschaften im Ausland.

Bauelemente können aufgrund technischer Erfordernisse Gefahrstoffe enthalten. Auskünfte darüber bitten wir unter Angabe des betreffenden Typs ebenfalls über die zuständige Vertriebsgesellschaft einzuholen.

Published by EPCOS AG

Marketing Communications, P.O. Box 80 17 09, 81617 Munich, GERMANY

© EPCOS AG 2000. All Rights Reserved. Reproduction, publication and dissemination of this brochure and the information contained therein without EPCOS' prior express consent is prohibited.

The information contained in this brochure describes the type of component and shall not be considered as guaranteed characteristics. Purchase orders are subject to the General Conditions for the Supply of Products and Services of the Electrical and Electronics Industry recommended by the ZVEI (German Electrical and Electronic Manufacturers' Association), unless otherwise agreed.

This brochure replaces the previous edition.

For questions on technology, prices and delivery please contact the Sales Offices of EPCOS AG or the international Representatives.

Due to technical requirements components may contain dangerous substances. For information on the type in question please also contact one of our Sales Offices.