

FRM6-SK7-P

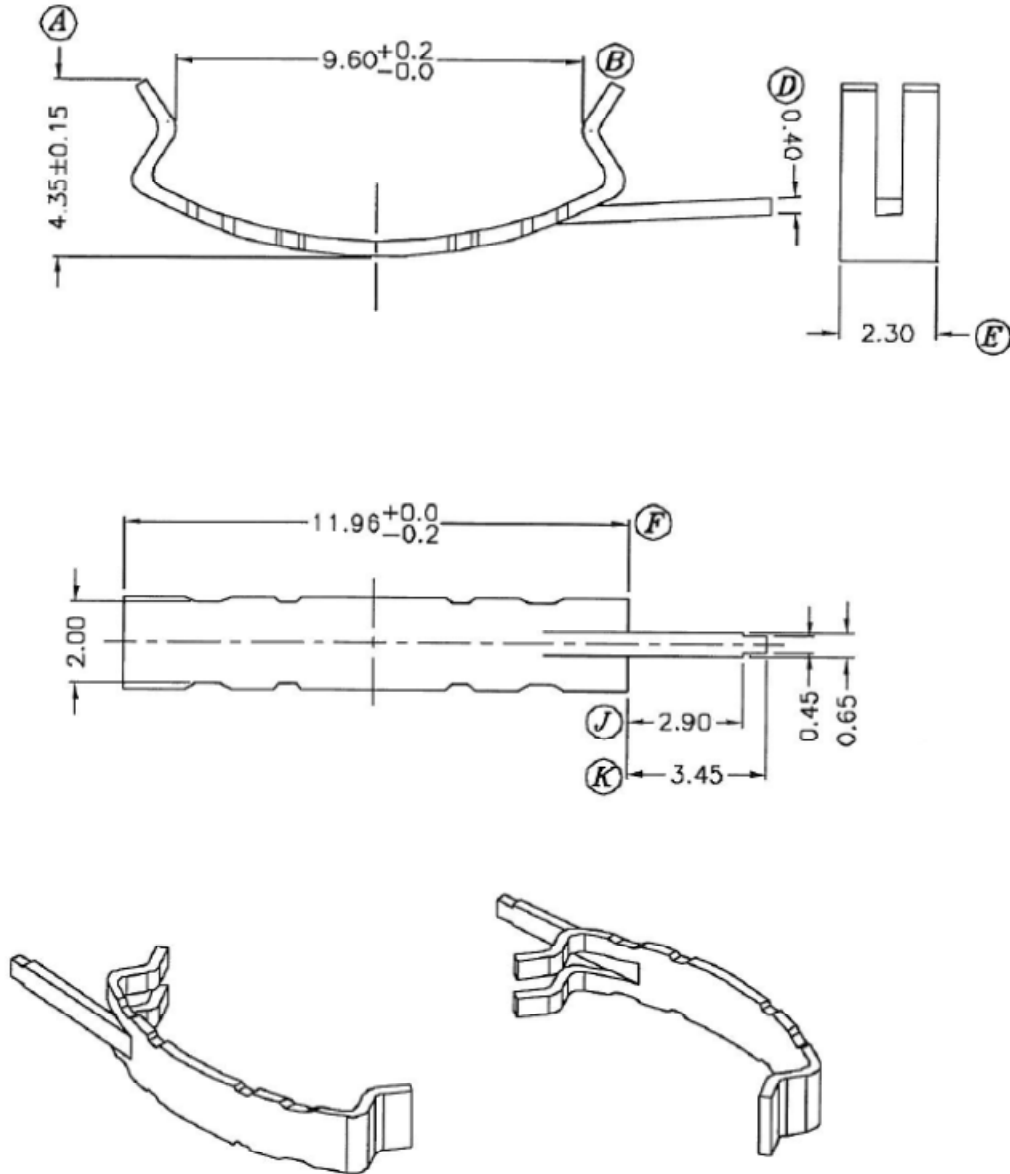

Dimensions in mm

Country of Origin: China	RoHS Certified: YES	Drawing Number: FRM6-SK7-P	
MH&W International Corp		Material: Tool Steel SK7	Finish: Tin
Phone 201-891-8800 Email: sales@mhw-intl.com		Part Number: FRM6-SK7-P	Item ID: C-027