

BEFD20-1110GADS-P S2004-4

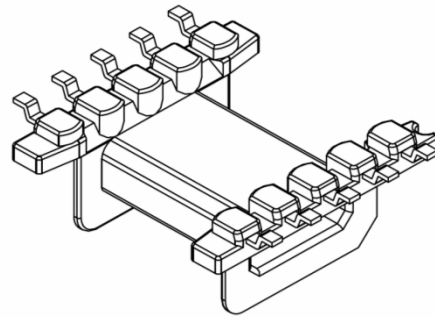
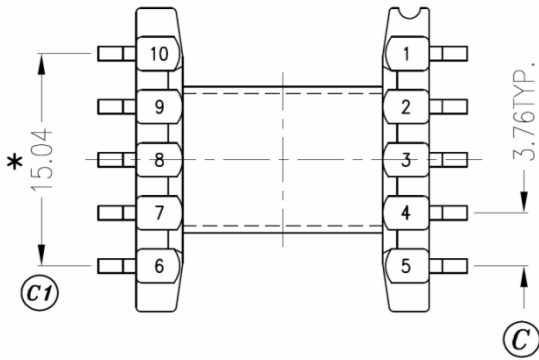
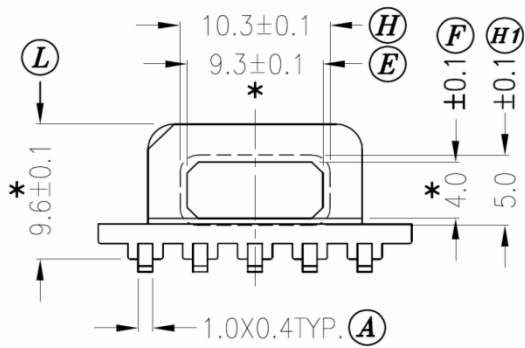
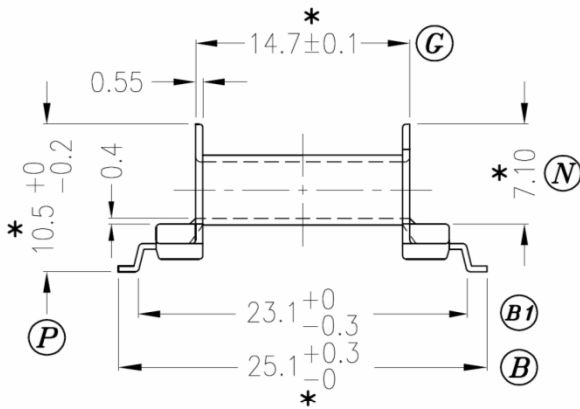
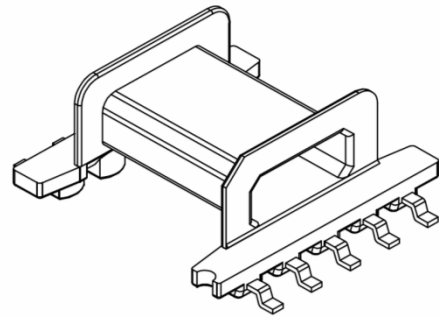
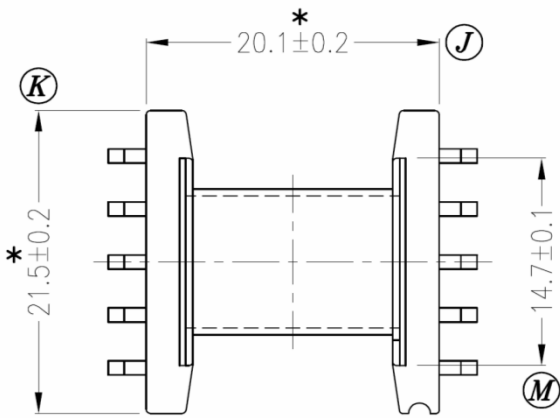
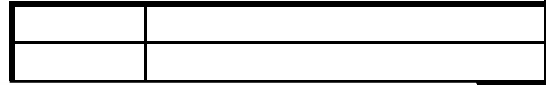

Dimensions in mm

Country of Origin: China	RoHS Certified: YES	UL Molder Certification: E163831
Bobbin Material: Sumitomo PM9630	Drawing Number: BEFD20-1110GADS-P S2004-4	
UL File: E41429	UL Rec: 94-V0	S-2004-4
Pin Material: PHOSPHOR BRONZE (DS) CuSn6		Pin Tension: 1.0Kgm min
Finish: Sn		Part Number: BEFD20-1110GADS-P S2004-4
MH&W International Corp Phone 201-891-8800 Email: sales@mhw-intl.com		