

# Scaling Issues for Common Mode Chokes to Mitigate Ground Currents in Inverter-Based Drive Systems

Annette Muetze

Electrical and Computer Engineering  
University of Wisconsin-Madison, USA

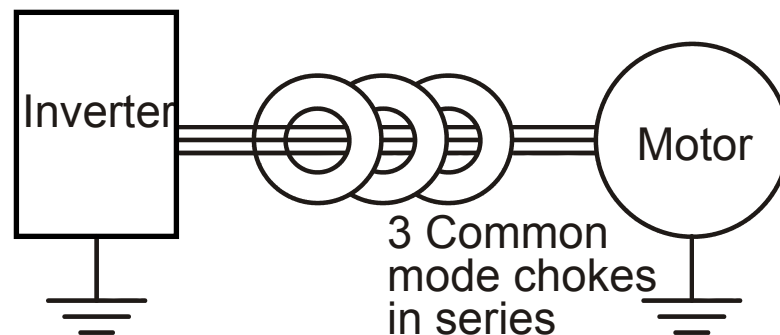

Source: Magnetec GmbH

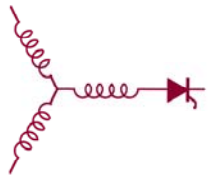

# Outline

- Motivation
  - ...to use common mode chokes in the inverter-output → requirements?
- Influence of the Inductance Value on the Current Reduction
  - Equivalent circuit, general case and un-damped case
- Physics of Common Mode Chokes
  - Fundamentals, wound and feed-through chokes

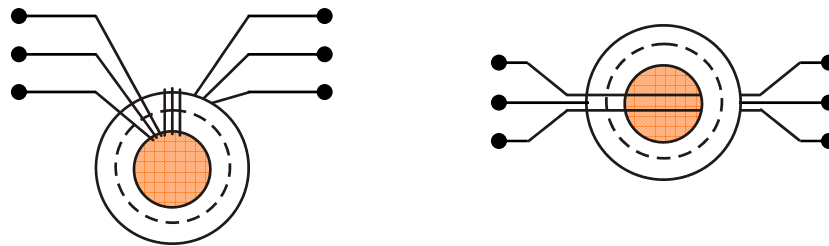

- Design Criteria
  - Window area, current-to-diameter ratio, minimum diameter,...
- Measurement Results
- Summary

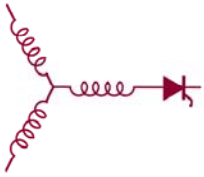

# Motivation

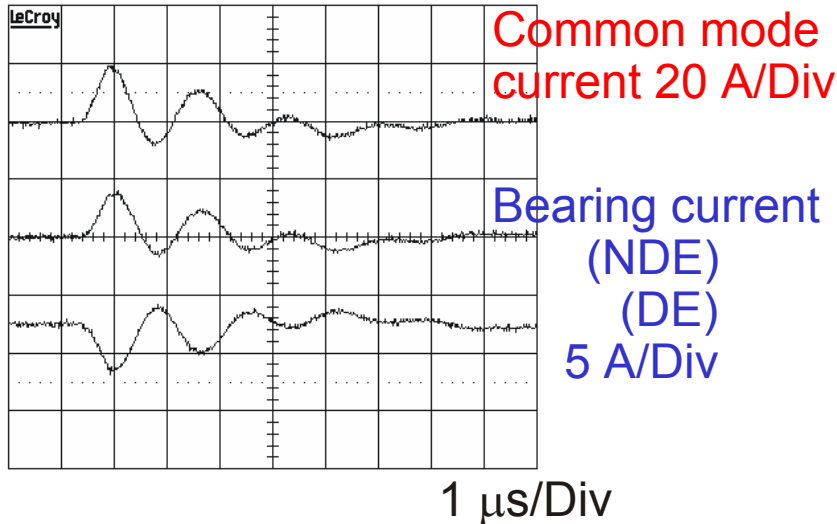

Circulating bearing currents  
motor speed  $n = 3000$  /min

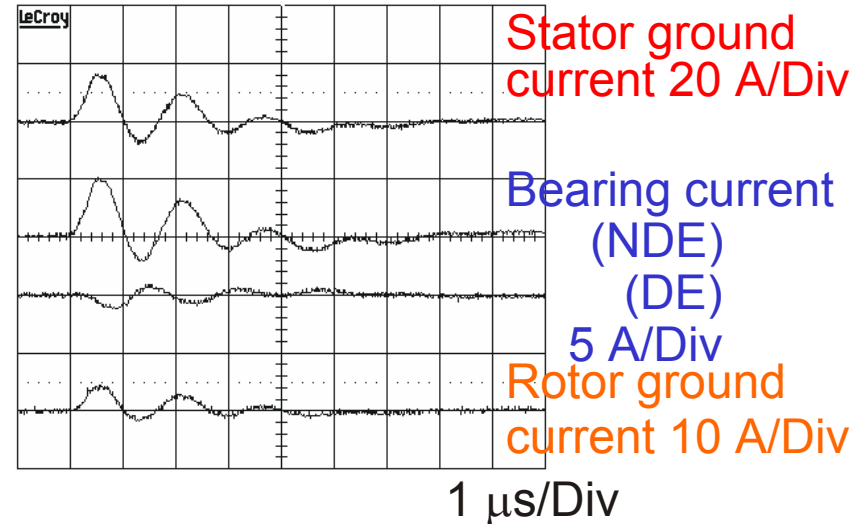

Bearing currents due to rotor ground currents,  
motor speed  $n = 15$  /min, rotor grounded on DE-side



Squirrel-cage induction motor, frame size 400 mm, 500 kW rated power, bearing temperature  $T_b \approx 70^\circ\text{C}$  (Measurements were obtained in the frame of a research project at Darmstadt University of Technology, Institute of Prof. Binder)

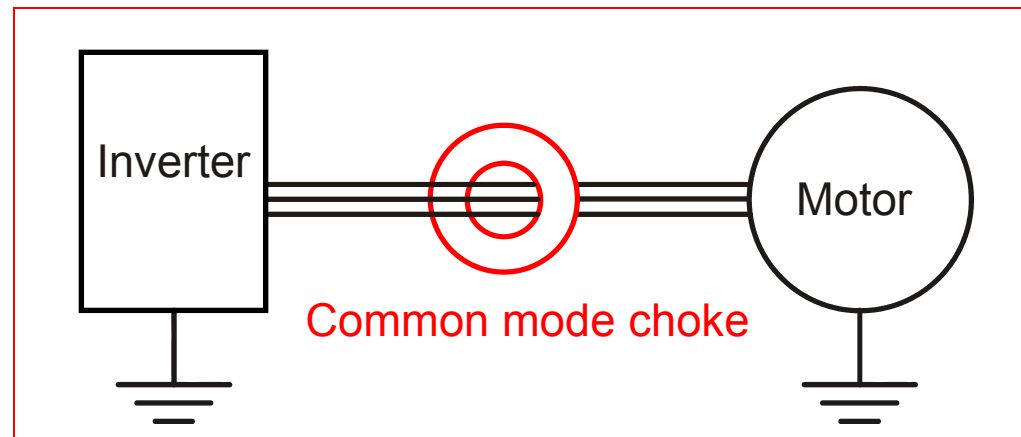

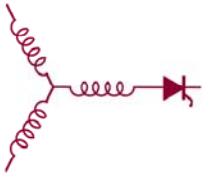

# Modeling: Lumped Parameter Circuit

▷ Approach:

*RLC*-Circuit (*L*: function of cable, *R* and *C*: function of motor)  
[Ogasawara, Akagi, 1996]

▷ The peak HF common mode current amplitude is searched for:

$$I_{\text{com}} = f\left(\frac{v_{\text{Lg}}}{dt}, L_{\text{com}}, C_{\text{wf}}\right) = f(m, L_{\text{com}}, C_{\text{wf}})$$

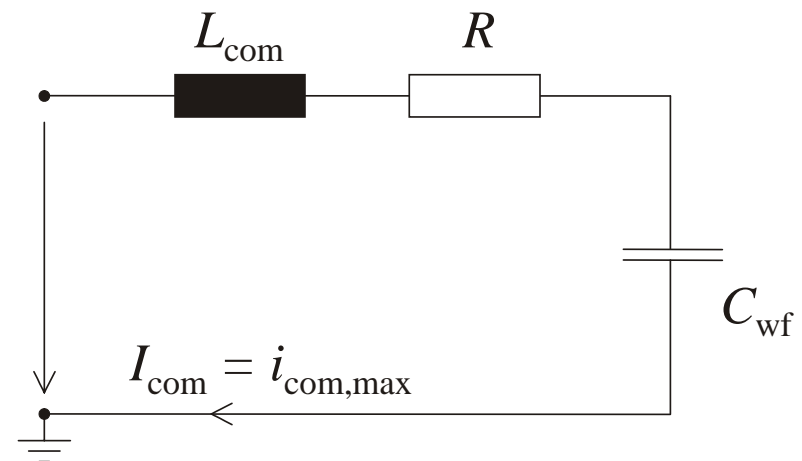
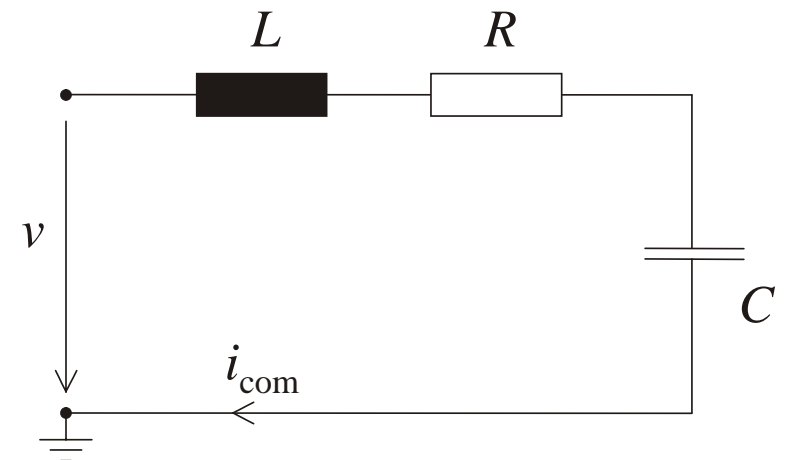
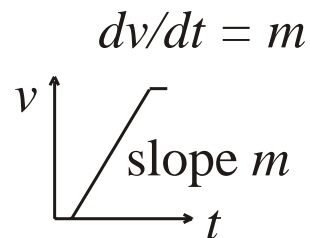

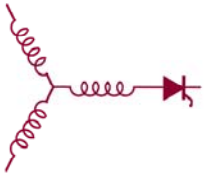

# Lumped Parameter Circuit: Parameters

Common mode inductance  
... required value ...???

Related to the motor only  
Damping due to motor frame resistance including skin effect;  
...up to some tens of  $\Omega$

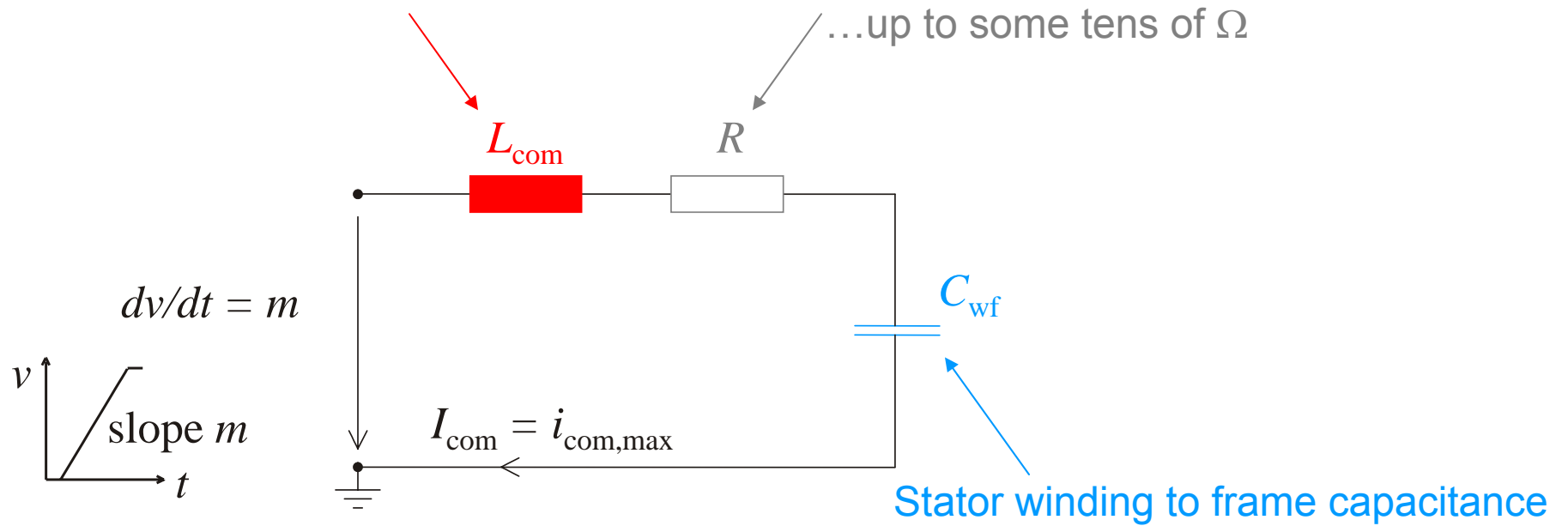

## Assumptions:

- short motor leads ( $L_{cable} \approx 0$ )
- $I_{com} = i_{com,max}$  occurs during rise time  $t_r$

All values are per phase values.

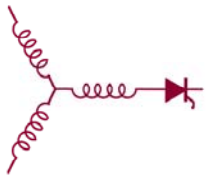

# Influence of $L_{\text{com}}$ on the Current Reduction: Problem Formulation

▷  $i_{\text{com}}(t) = f(m, L_{\text{com}}, C_{\text{wf}})$

▷  $i_{\text{com}}(t) = f(\omega_0, Z_0, \xi)$

where  $\omega_0 = \sqrt{\frac{1}{L_{\text{com}} C_{\text{wf}}}}$      $Z_0 = \sqrt{\frac{L_{\text{com}}}{C_{\text{wf}}}}$      $\xi = \frac{R}{2} \sqrt{\frac{C_{\text{wf}}}{L_{\text{com}}}}$

1. Under-damped case
2. Critically-damped case
3. Over-damped case



$i_{\text{com}}(t) = \dots \rightarrow I_{\text{com}} = f(m, L_{\text{com}}, C_{\text{wf}}) = f(\omega_0, Z_0, \xi) \dots$



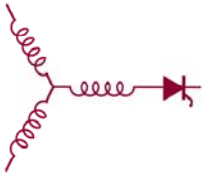

# Influence of $L_{com}$ on the Current Reduction: General Case

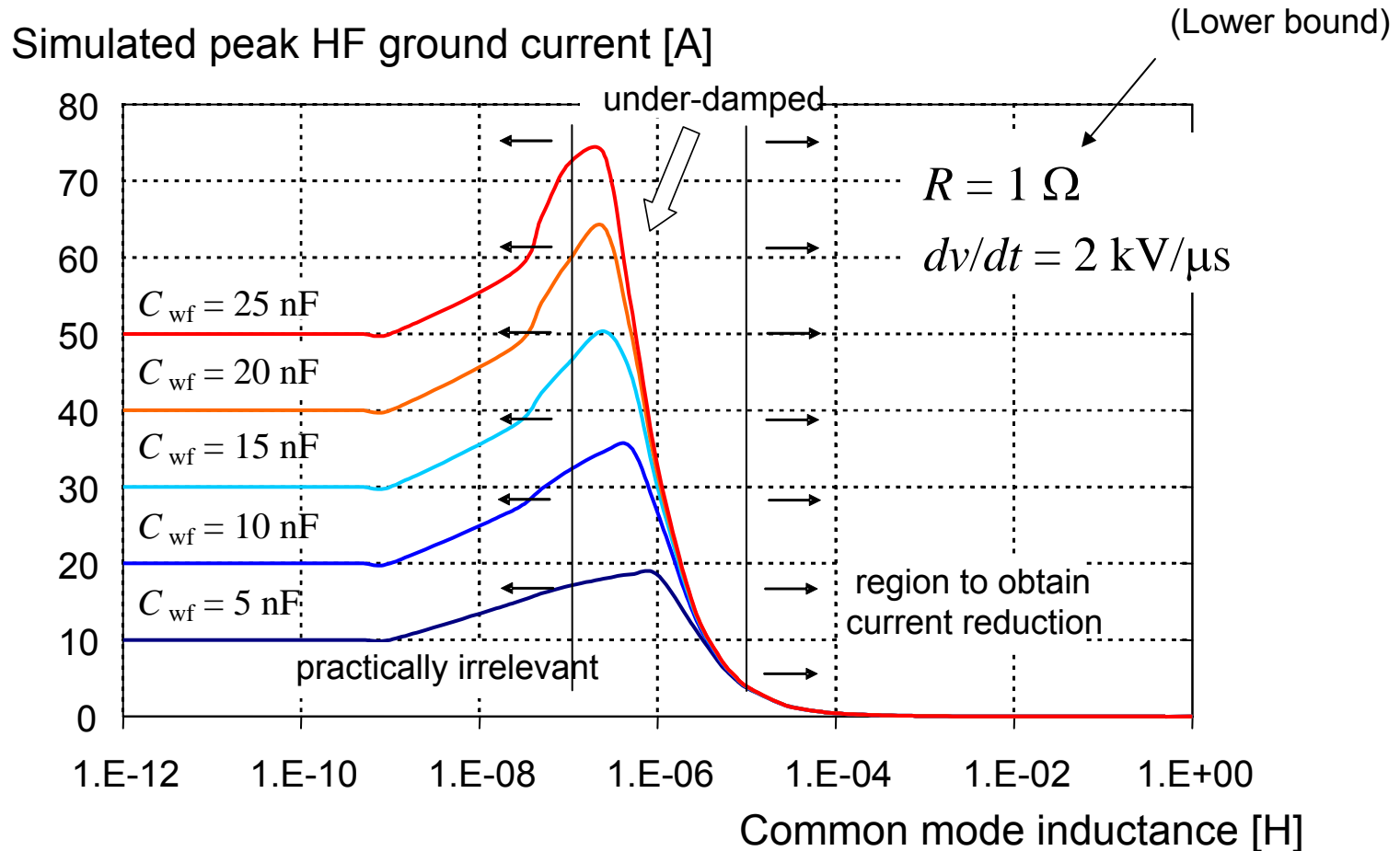

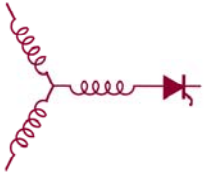

# Influence of $L_{com}$ on the Current Reduction: General Case cont.

Simulated peak HF ground current [A]

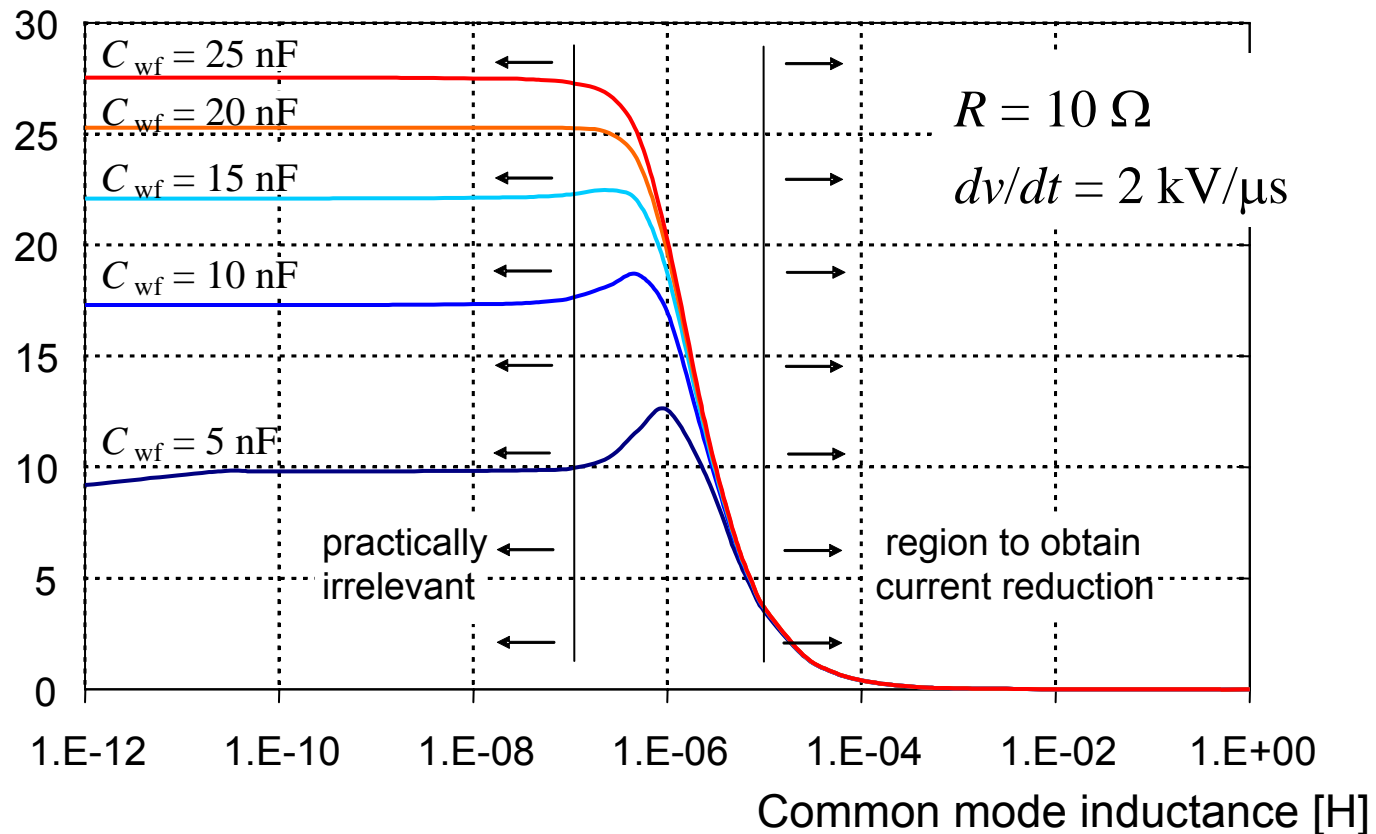



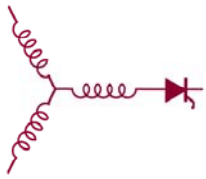

# Influence of $L_{\text{com}}$ on the Current Reduction: Un-damped Case

- ▷  $i_{\text{com}} = mC_{\text{wf}}\{1 - \cos(\omega_e t)\}$
- ▷  $I_{\text{com}} = 2mC_{\text{wf}}$

Minimum value of common mode inductance [uH]

$L_{\text{com}} \geq L_{\text{com,min}} = \frac{1}{C_{\text{wf}}} \left(\frac{t_r}{\pi}\right)^2$

$t_r = \frac{T}{2}$

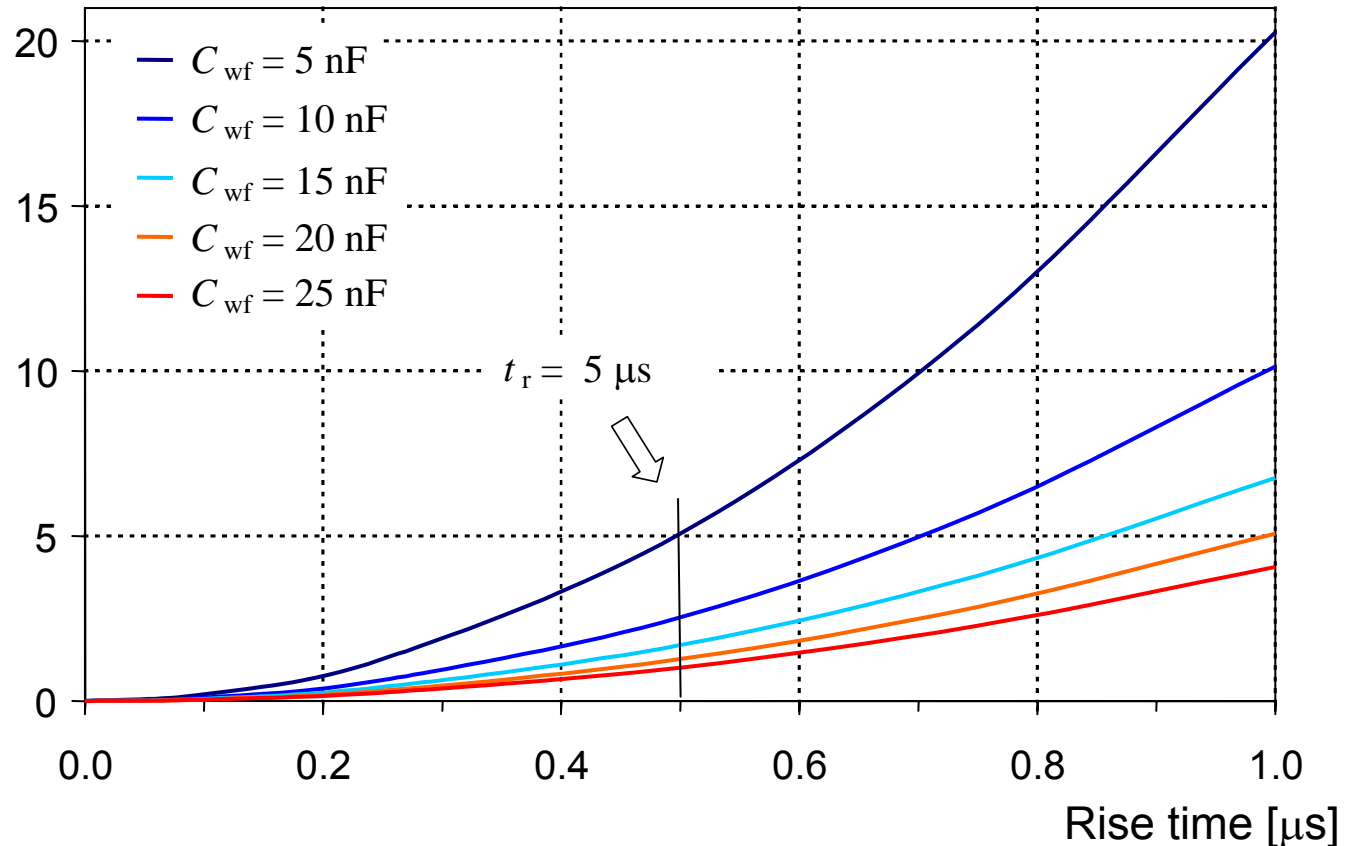

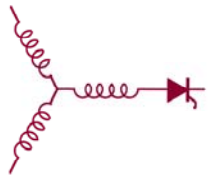

# Outline

- Motivation
  - ...to use common mode chokes in the inverter-output → requirements?
- Influence of the Inductance Value on the Current Reduction
  - Equivalent circuit, general case and un-damped case
- Physics of Common Mode Chokes
  - Fundamentals, wound and feed-through chokes

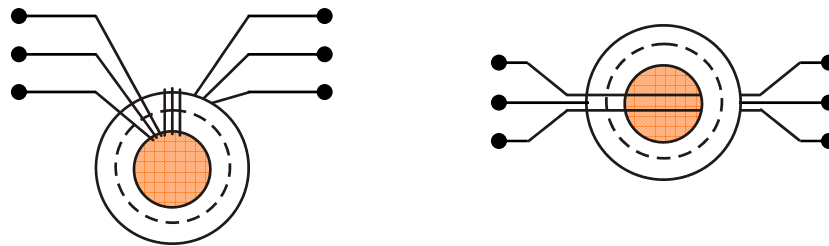

- Design Criteria
  - Window area, current-to-diameter ratio, minimum diameter,...
- Measurement Results
- Summary

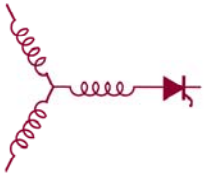

# Physics of Common Mode Chokes

*Wound choke:*

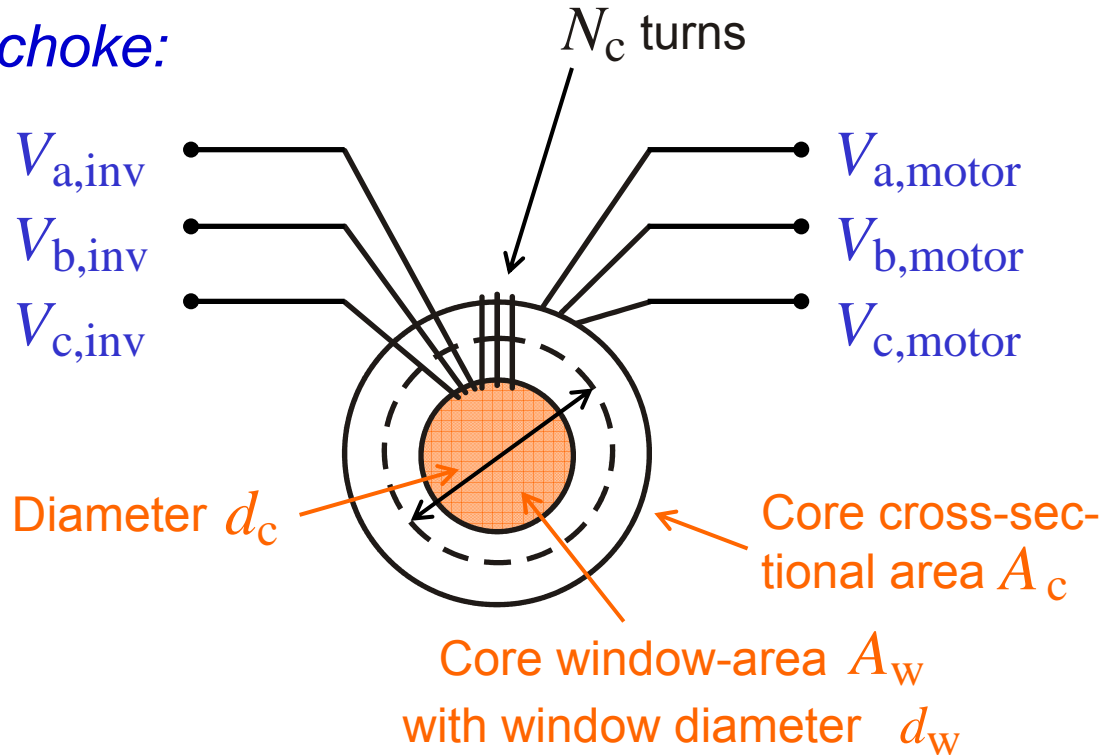

*Inductance value:*

$$L_{\text{com}} = \frac{N_c^2 \mu A_c}{\pi d_c}$$

(Un-gapped cores)

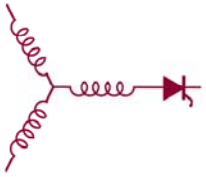

# Physics of Common Mode Chokes cont.

Wound choke:

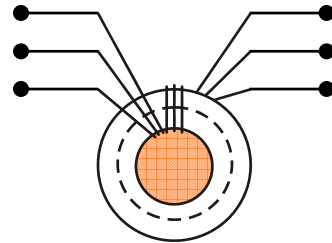

$$L_{\text{com}} = \frac{N_c^2 \mu A_c}{\pi d_c}$$

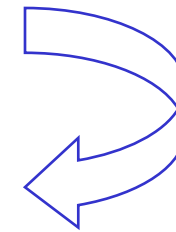

$$N_c = 1$$

Feed-through choke:

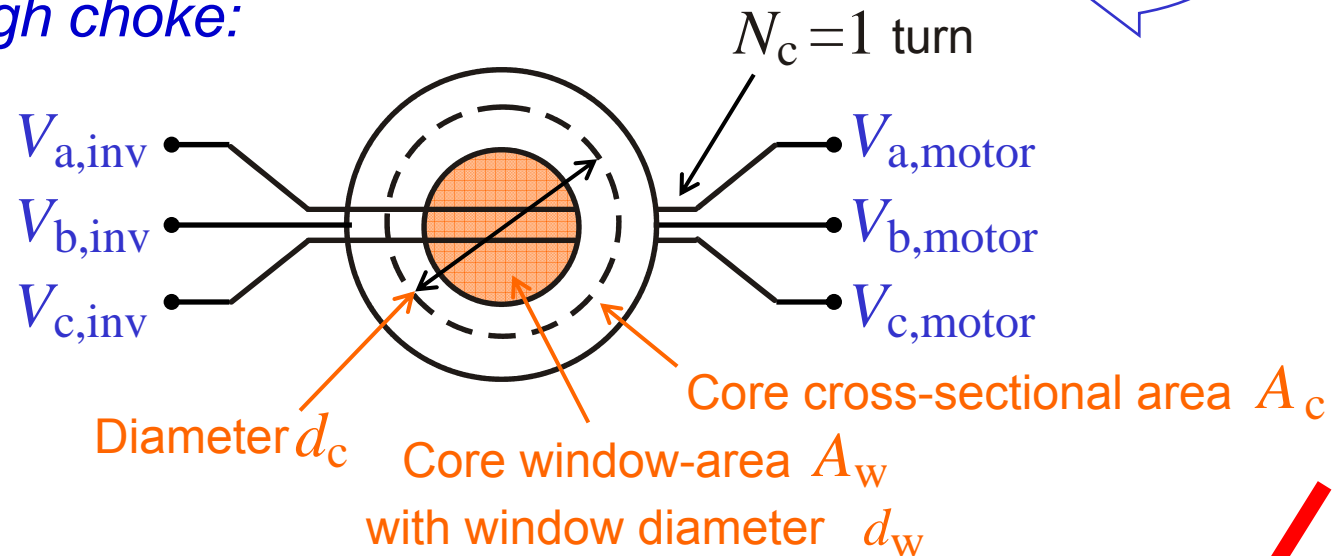

Inductance value:

$$L_{\text{com}} = \frac{\mu A_c}{\pi d_c}$$

(Un-gapped cores)

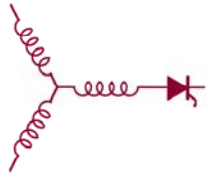

# Outline

- Motivation
  - ...to use common mode chokes in the inverter-output → requirements?
- Influence of the Inductance Value on the Current Reduction
  - Equivalent circuit, general case and un-damped case
- Physics of Common Mode Chokes
  - Fundamentals, wound and feed-through chokes

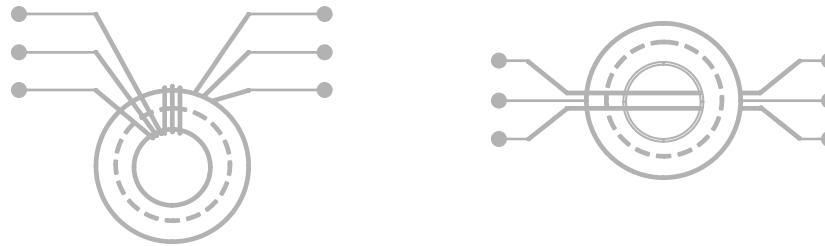

- Design Criteria
  - Window area, current-to-diameter ratio, minimum diameter,...
- Measurement Results
- Summary

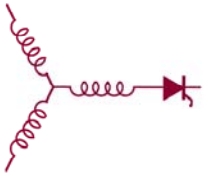

# Accommodation of the Motor Leads

Minimum core window area and bore of feed-through toroidal cores for different cable cross-sectional areas:

$$N_c = 1, k_w = 0.4$$

Cable cross-sectional area	Current carrying capability per individual cable <sup>*)</sup>	Core minimum window area	Core minimum bore diameter
70 mm <sup>2</sup>	207 A	525 mm <sup>2</sup>	26 mm
150 mm <sup>2</sup>	335 A	1125 mm <sup>2</sup>	38 mm
300 mm <sup>2</sup>	523 A	2250 mm <sup>2</sup>	54 mm

More than a factor of 2 smaller than the minimum bore diameter to avoid saturation! – Already at 1 turn!

<sup>\*)</sup> At 30°C ambient temperature, according to DIN VDE 0276 Part 1000

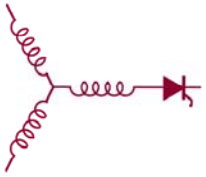

# Maximum $d_c/I_{com}$ – Ratio for Avoiding Core Saturation

$$\left\{ \frac{I_{com}}{d_c} \right\}_{max} = \frac{\pi B_s}{N_c \mu}$$

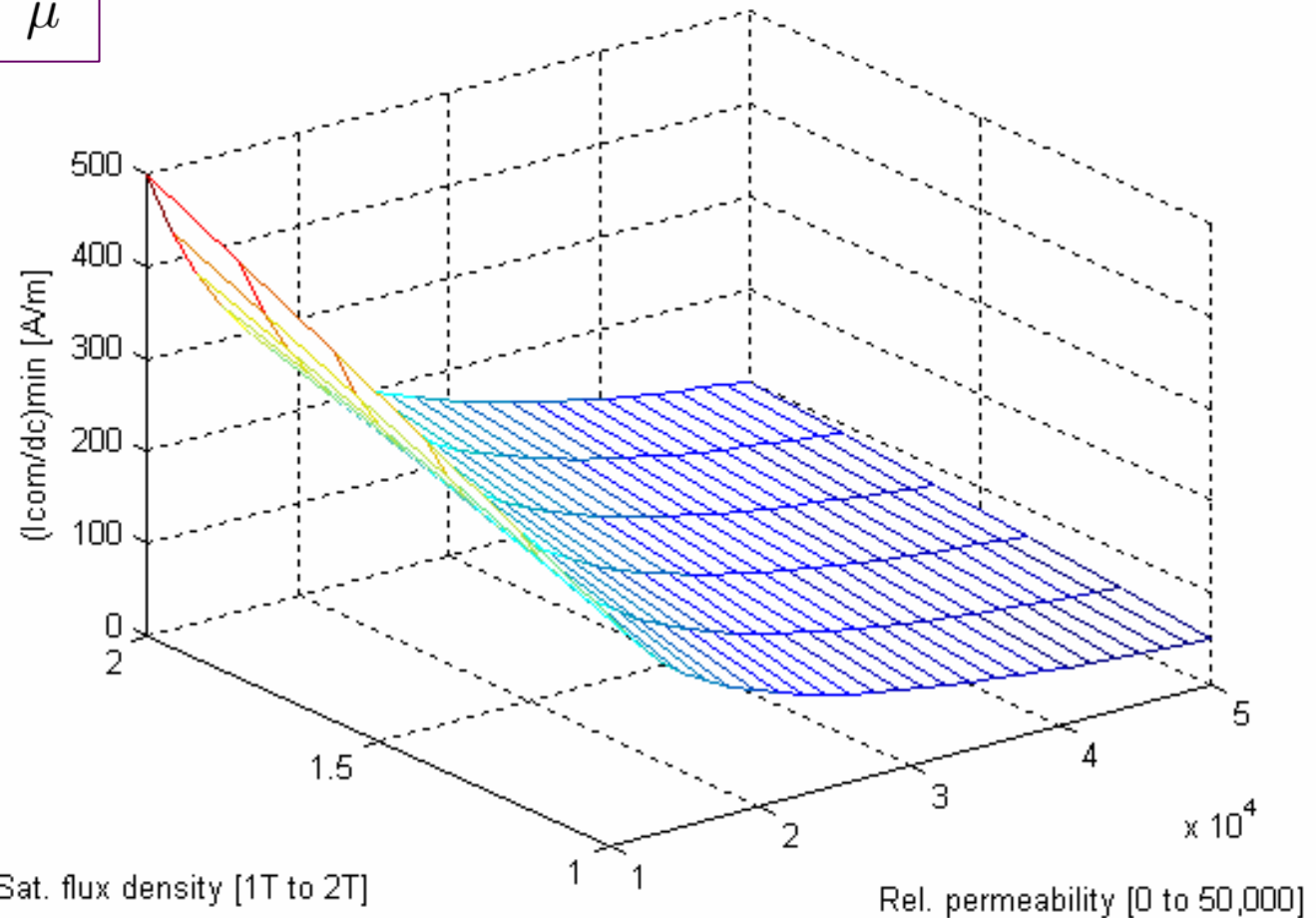

(Un-gapped cores)

Sat. flux density [1T to 2T]

Rel. permeability [0 to 50,000]

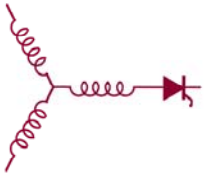

# Minimum Core Diameter for Avoiding Core Saturation

$$d_{c,\min} = \frac{I_{\text{com}} 4\pi 10^{-7} \mu_r}{B_s}$$

High value  
by intention

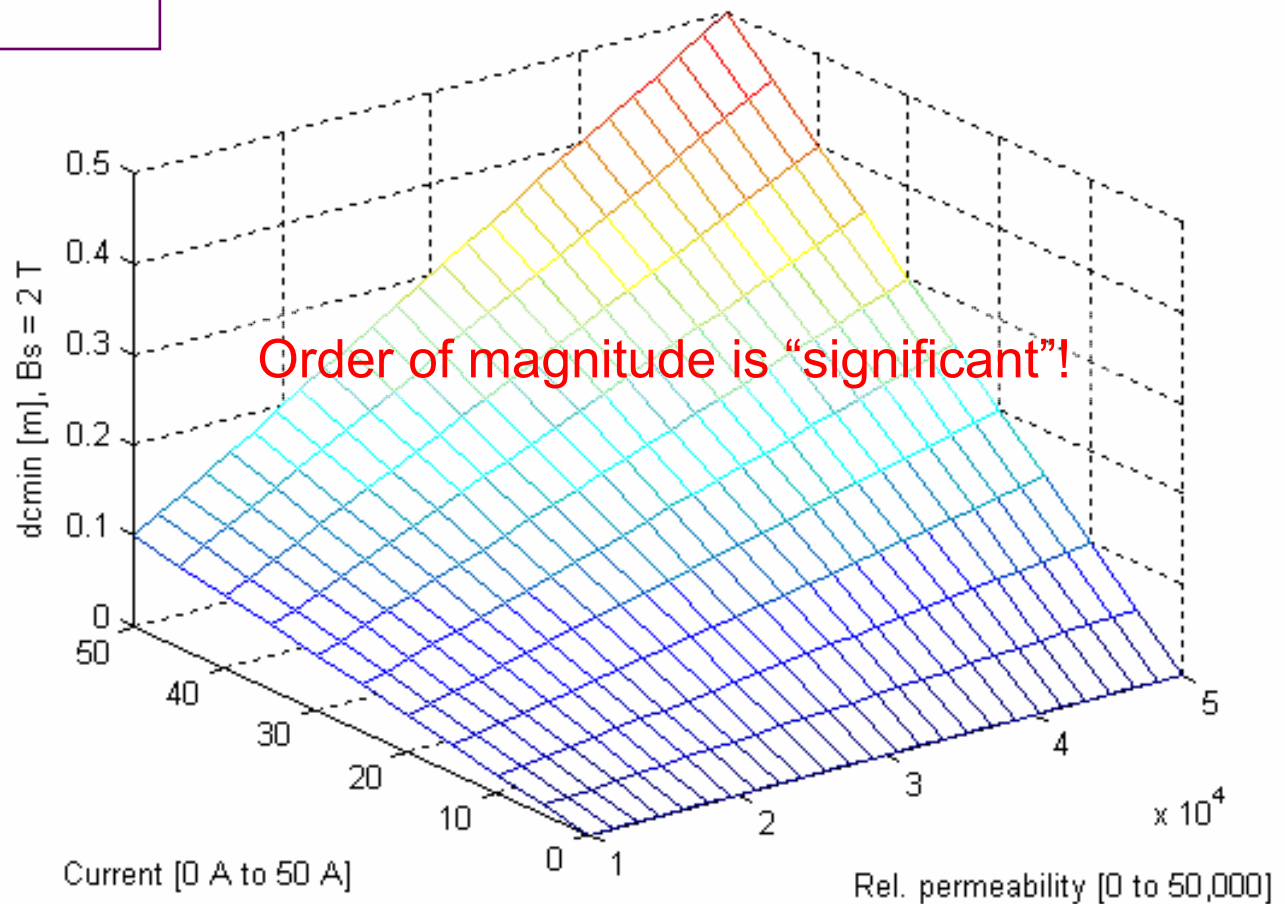

(Un-gapped cores)



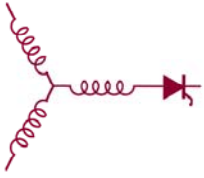

# Cross Sectional Area as Function of $L_{com}$

Core cross sectional area [mm<sup>2</sup>]

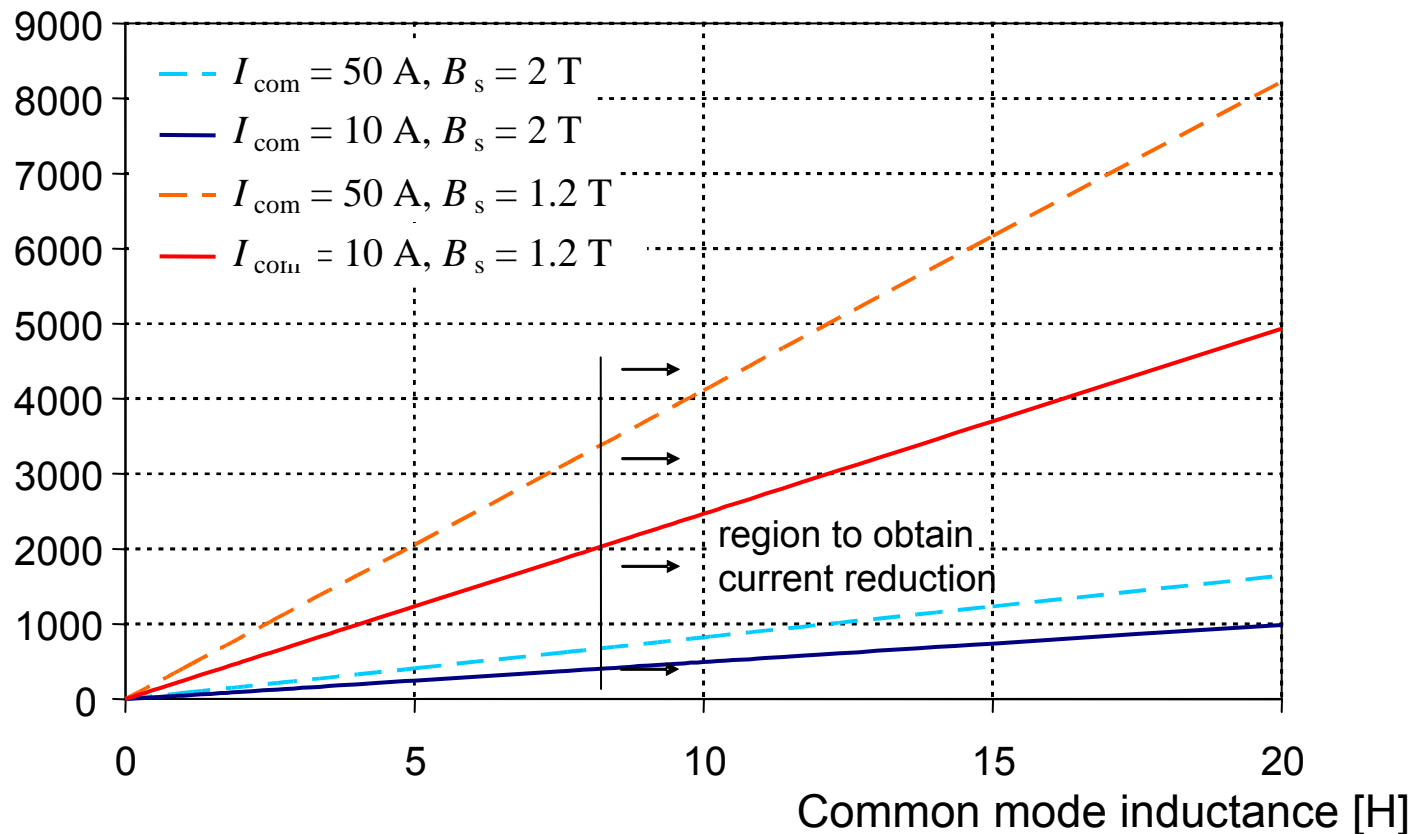

(Un-gapped cores, constant  $\mu$ )

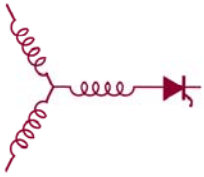

# Use of Several Feed-Through Cores in Series

- ▷ Large cross sectional area required to achieve  $L_{com}$
- ▷ Increase of the  $N_c$  not an option because of saturation
  - ▷ Use several cores in series

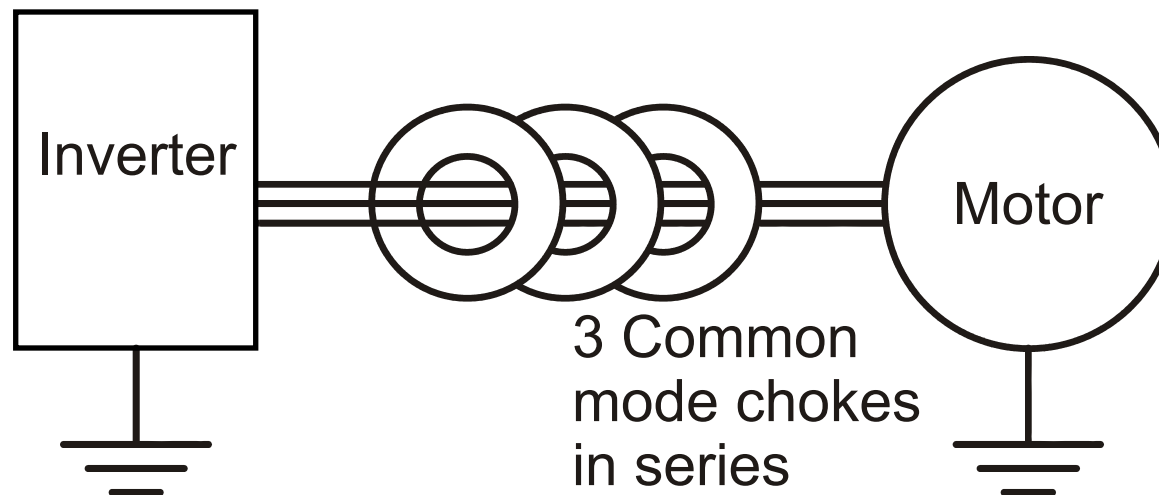

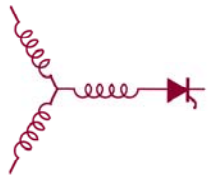

# Outline

- Motivation
  - ...to use common mode chokes in the inverter-output → requirements?
- Influence of the Inductance Value on the Current Reduction
  - Equivalent circuit, general case and un-damped case
- Physics of Common Mode Chokes
  - Fundamentals, wound and feed-through chokes

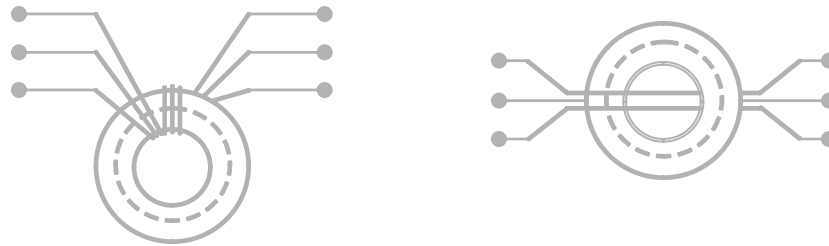

- Design Criteria
  - Window area, current-to-diameter ratio, minimum diameter,...
- Measurement Results
- Summary

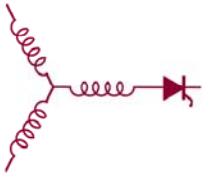

# Measurement Results

- Commercially available un-gapped toroidal core  
("Cool Blue<sup>®</sup>" of Magnetec GmbH)
  - Nano-crystalline material with  $\mu_r = 30,000$  (10 kHz)
  - Tabulated inductance (20...30) $\mu\text{H}$
- Drive with  $C_{wf} = 8 \text{ nF}$ ,  $dv_{Lg}/dt = 2 \text{ kV}/\mu\text{s}$ 
  - Reduction of  $I_{com} = 28 \text{ A}$
  - 1 core: by 15%
  - 2 cores: by 36%
- Minimum  $d_c = 280 \text{ mm}$   
 $\approx$  twice actual value
  - Reduction of the choke performance by  $\approx 50\%$
  - Compares well with above Figures

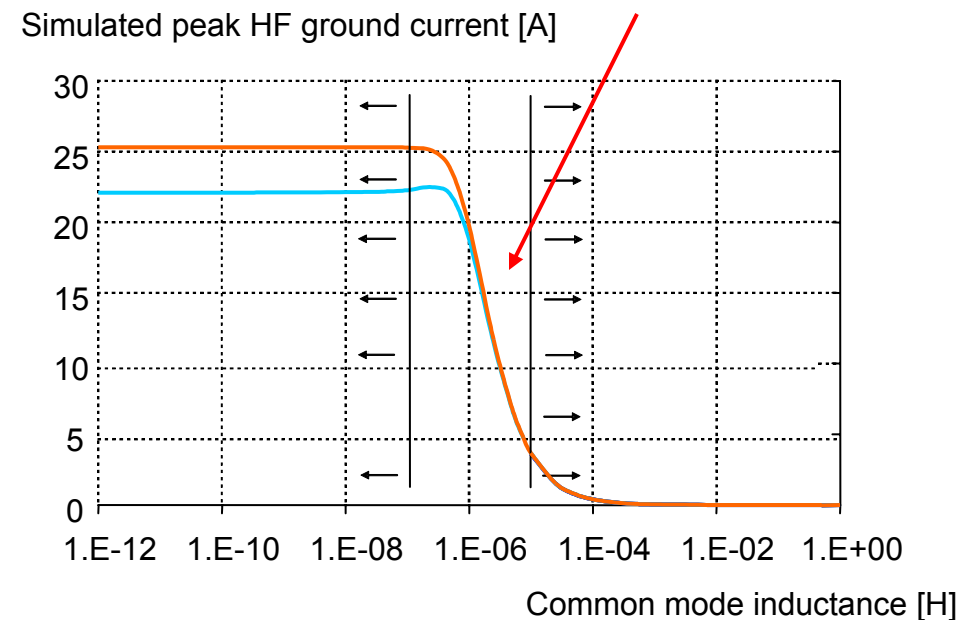

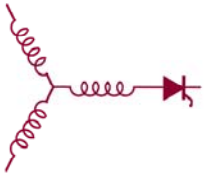

# Summary



1. Minimum inductance value of the chokes: in the order of  $10 \mu\text{H}$
2. Rather large values of  $I_{\text{com}}$  require a minimum bore diameter for avoiding saturation that results in a core window area large enough to accommodate the motor leads
3. Any number of turns  $> 1$  will likely result in increased saturation ( $\rightarrow$  not improve the choke performance) (Un-gapped cores)
4. Aiming for a higher value of relative permeability than 10,000 is arguable (Un-gapped cores)
5. Use of several cores in series